

香港四邑商工總會陳南昌紀念學校
HKSyc&IA CHAN NAM CHONG MEMORIAL SCHOOL

中學IT創新實驗室



申請分享

王詠欣主任



學校背景



香港四邑商工總會陳南昌紀念學校為一間中度智障特殊學校，學生多有自閉症、過度活躍症或其他不同的學習障礙。

本校深信「教育比智力重要」，一直持續引入不同的教學法，讓學生受惠。

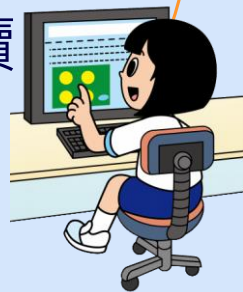

成功申請項目

125

智能防疫機械人在校園

01 Artificial Intelligence ROBOT
for wearing mask at school

(20-21)

343

機械人編程我都得

02 Robot Coding- I can

(21-22)

789

VR創作體驗短期課程

VR Creator short term course

03 AR魔法文字創造師

AR Magic Word Creator

(22-23)

由淺入深、多元化



智能口罩機械人 Artificial Intelligence ROBOT for wearing mask at school

(20-21)

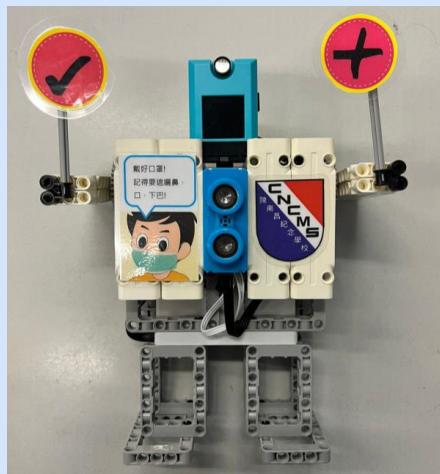

認識人工智能、體驗編程，
並與人工智能口罩機械人作互動。

智能口罩機械人 Artificial Intelligence ROBOT for wearing mask at school

(20-21)

複雜簡單化

編程?

開始
舉手
唱歌
轉左
向前行
完結

編排

機械人程式 訓練程式

正如前面所說，所有的AI都必須經過訓練。此程式就是負責進行模型的訓練。

按A, B 及 Koi上的按鈕便能夠為分類增加訓練素材。

最後按A+B便能夠儲存

智能口罩機械人 Artificial Intelligence ROBOT for wearing mask at school

(20-21)



智能口罩機械人 Artificial Intelligence ROBOT for wearing mask at school

(20-21)

校本化

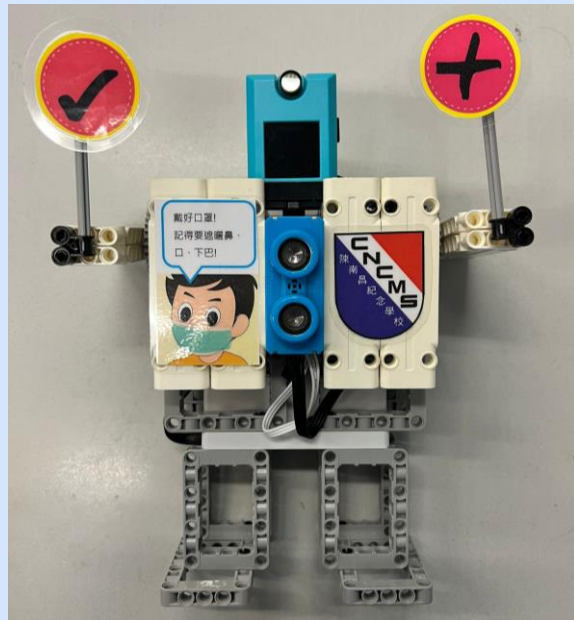
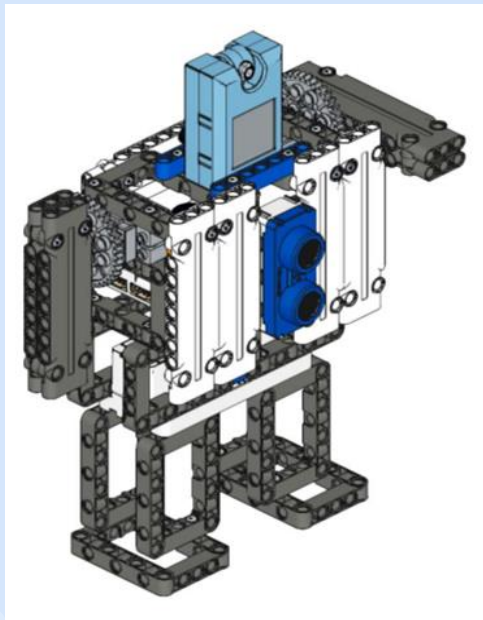

機械人編程我都得 Robot Coding-I can

(21-22)

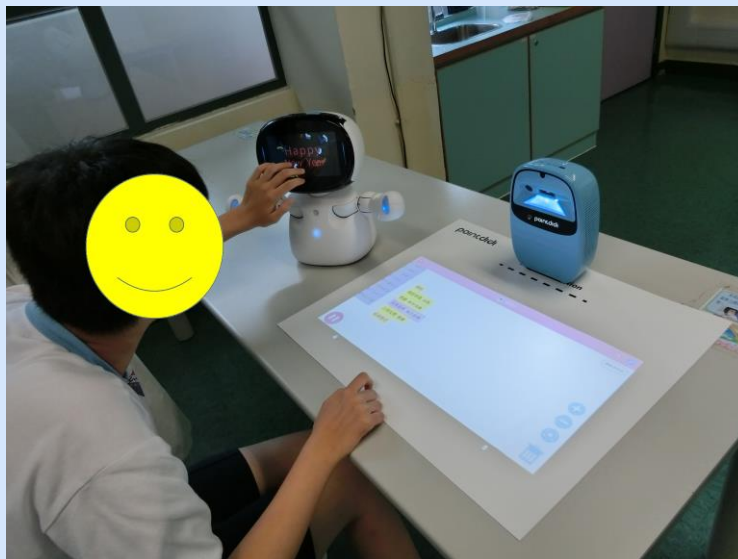

機械人編程我都得 Robot Coding-I can

(21-22)

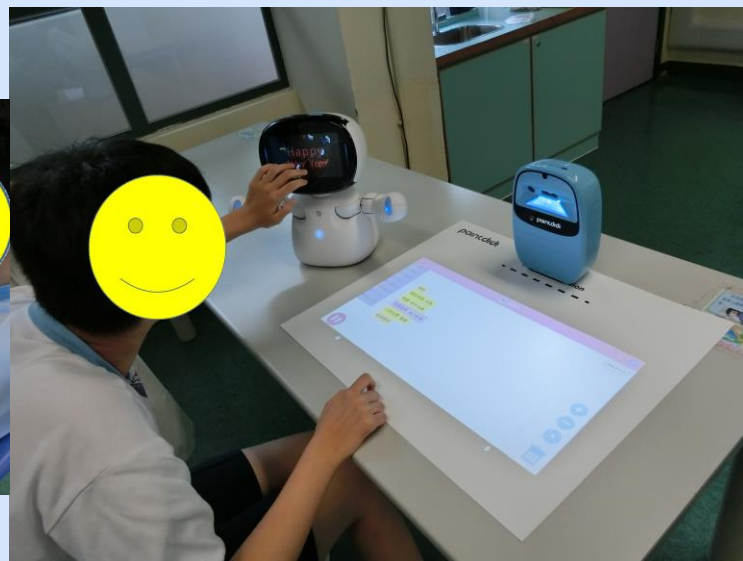
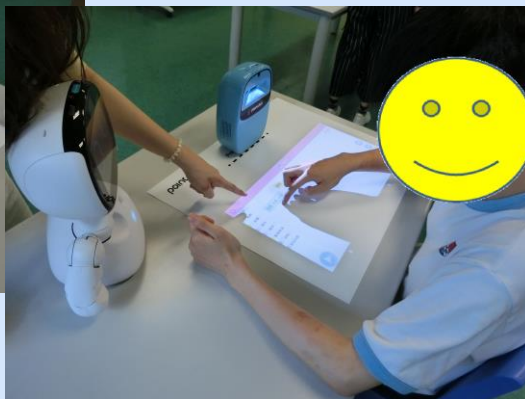
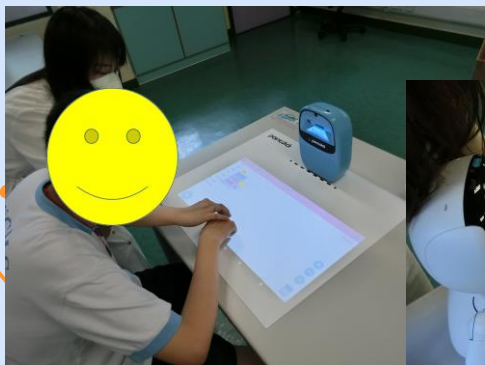

逐步掌握

自行編程、 做任務

幫助學習能力高、
行為稍遜的學生
投入學習



VR創作體驗短期課程

VR Creator short term course

(22-23)

活用校方已有資源-VR CAVE，以短期課程形式，教導學生拍360影片的技巧及創作VR影片。



AR魔法文字創造師

AR Magic Word Creator

(22-23)

活用自閉症學生獨特的畫作，再結合AR，讓學生把自己的畫作創作成一個個會動起來的AR魔法文字，讓有讀寫障礙的學生更投入學習中文。



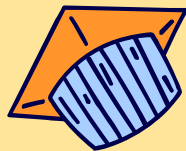

循序漸進，設計合宜的活動，讓學生亦能成為一位創作者。

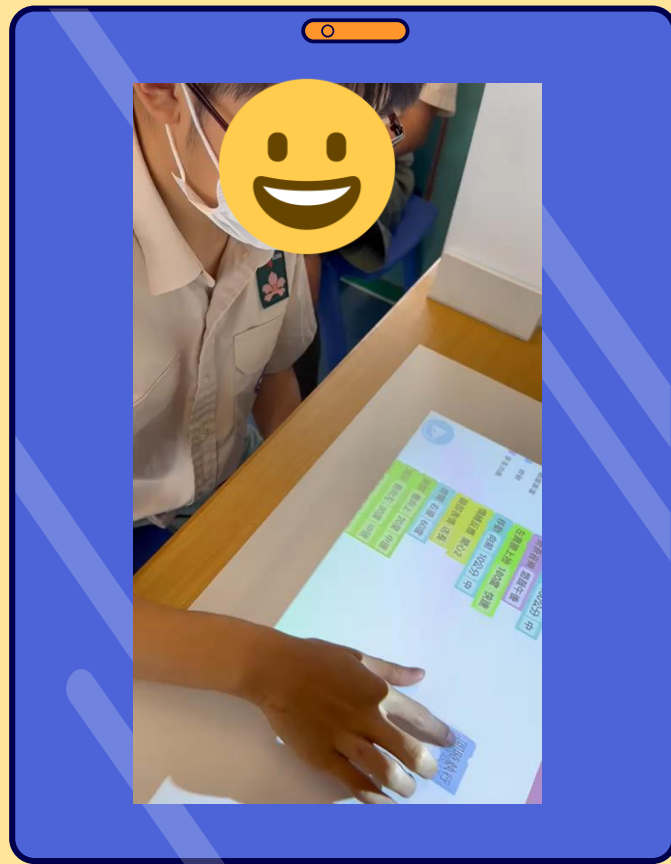

THANKS!

如有查詢，可聯絡：

王詠欣主任

wy_wong@cncms.edu.hk

26159048

